

Robertshaw®

8400

DIGITAL
NON-PROGRAMMABLE
THERMOSTAT

G

GAS

E

ELECTRIC

O

OIL

H

HEAT PUMP

1 Heat / 1 Cool

NEW



**User's Manual
Quick Start
Installation**



110-1086

Application

The Robertshaw 8400 is a single-stage thermostat designed to control 24 VAC gas or electric heating and cooling systems or single-stage heat pump.

Features

- Low battery indicator
- Large back lit display
- Adjustable temperature differential: 1°F to 3.0°F (0.5°C to 1.5°C)
- Compressor short cycle protection
- Accuracy within $\pm 1^\circ$
- Zone system compatible as a master thermostat
- Permanent memory retention
- Fahrenheit/Celsius display option
- Adjustable from 45°F to 90°F (7°C - 32°C)
- Quick wire terminal block

IMPORTANT SAFETY INFORMATION WARNING:

- Always turn off power at main fuse or circuit breaker panel before installing, removing, cleaning, or servicing thermostat.
- Read all the information in this manual before installing this thermostat.
- **DO NOT CONNECT TO 120 VAC.** This is a 24 VAC low-voltage thermostat. Do not install on voltages higher than 30 VAC.
- All wiring must conform to local and national building and electrical codes and ordinances.
- Do not short (jumper) across terminals on the gas valve or at the system control to test installation. This will damage the thermostat and void the warranty.
- Do not connect ground to any terminal in this unit.



Recycling Thermostat

If this thermostat REPLACES a thermostat that contains mercury, **DO NOT** discard the old thermostat in the regular trash. Mercury is harmful to humans and the environment. For this reason, do not open, break, or crush the mercury cell. If mercury leaks from a damaged cell, **DO NOT** touch or handle mercury with bare hands. Use protective, non-absorbent gloves to place mercury into a sealable container. Fill the container with sand or another absorbent material and seal the container completely.

Return the mercury or mercury products, in a sealed container, to Invensys Climate Controls or a local recycling center for proper disposal. If you have any questions, call Robertshaw technical support at 1-800-445-8299.

Invensys Climate Controls
28C Leigh Fisher Blvd.
El Paso, TX 79906
Attn: Mercury Recycling Center

Step 1: Replacing Existing Thermostat

IMPORTANT SAFETY INFORMATION WARNING:

In heat pump applications, do not connect anything to the W1 terminal. When switched to HP mode, W1 is connected internally to Y1 on the thermostat.

Wiring Table

Old Terminal	New Label	Description
M,W,Rh,R5 or 5	Rh	Heat transformer, hot side
V or Rc	Rc	Cool transformer, hot side
Y or Y6	Y1	Cooling control
H,W, or 4	W1	Heating control
F or G	G	Fan control relay
O	O	Cool active reversing valve
B	B	Heat active reversing valve

NOTE: ON SOME OLDER MODELS, THE C TERMINAL CAN BE EITHER THE COOLING CONTROL OR THE COMMON SIDE OF THE TRANSFORMER. CHECK FURNACE WIRING DIAGRAM TO VERIFY C TERMINAL. IF IT IS THE COMMON SIDE OF THE TRANSFORMER, CAP THE WIRE AND TUCK INTO THE WALL. IF IT IS THE COOLING CONTROL, CONNECT TO THE Y TERMINAL.

1. Turn off power to heating and cooling system.
2. Remove cover from old thermostat to expose wires (Figure 1).
3. Disconnect wires one at a time from existing terminals. Use enclosed labels to mark existing wires. Refer to cross references in the Wiring Table if existing wiring does not directly match the labels.
4. Remove existing thermostat base from wall.

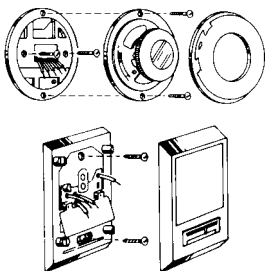



Figure 1

Step 2: Installing Model 8400 Thermostat

NOTE: FOR NEW INSTALLATIONS, MOUNT THERMOSTAT ON INSIDE WALL, FIVE FEET ABOVE THE FLOOR. DO NOT INSTALL BEHIND A DOOR, IN A CORNER, NEAR AIR VENTS, IN DIRECT SUNLIGHT, OR NEAR ANY HEAT OR STEAM GENERATING FIXTURES. INSTALLATION AT THESE LOCATIONS WILL AFFECT THERMOSTAT OPERATION.

1. Turn power off to the heating and cooling systems.
2. Place HEAT-OFF-COOL in OFF position (Figure 2).
3. Place  AUTO-ON switch into AUTO position (Figure 2).

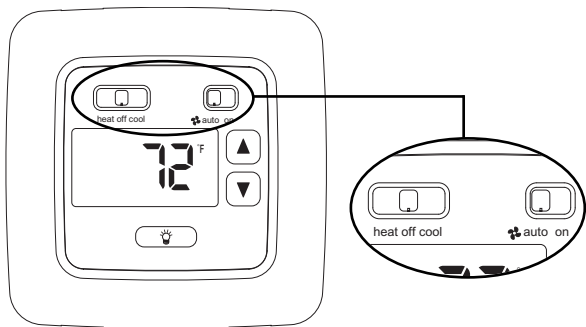

Figure 2

4. Remove the cover using a coin or screwdriver (Figure 3). Set aside.

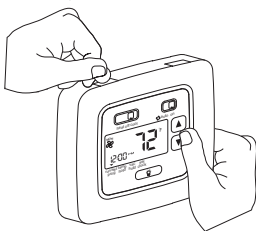

Figure 3

5. Place thermostat against the wall at desired location. Make sure wires will feed through opening (Figure 4) on base of thermostat.

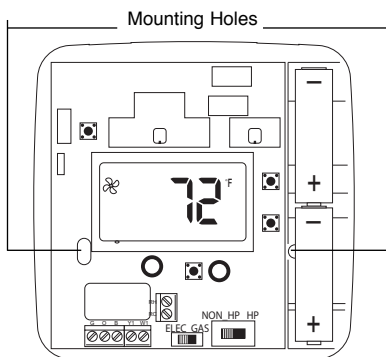
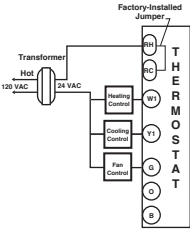

Figure 4

6. Mark placement of mounting holes (Figure 4). Set base aside.
7. If mounting on drywall, tap plastic anchors into wall.
NOTE: Enclosed plastic anchors do not require a drilled hole for drywall.
8. If mounting on a surface other than drywall, drill the marked holes using a 3/16" (5mm) drill bit.
9. Align base with plastic anchors and feed wires through opening.
10. Secure base to wall with supplied screws. **NOTE:** The thermostat will mount horizontally on a single gang junction box.
11. Strip end of wires 5/16" (8mm) if needed.
12. Terminal screws are already loose and ready for wire insertion. Insert wires into terminal strip (Figure 4) matching the label to the corresponding terminal (see Wiring Diagrams). Tighten screws.

◆ Wiring Diagrams

**HEAT/COOL
4-WIRE
SINGLE TRANSFORMER**



**HEAT ONLY
3-WIRE
SINGLE TRANSFORMER**

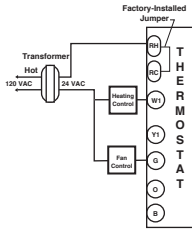

**HEAT ONLY
2-WIRE
SINGLE TRANSFORMER**

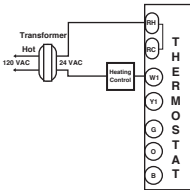

**COOL ONLY
3-WIRE
SINGLE TRANSFORMER**

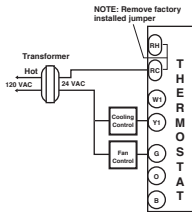

**HEAT/COOL
5-WIRE
TWO TRANSFORMER**

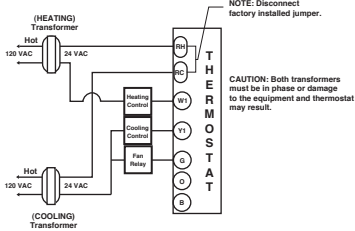

**HEAT PUMP WITH
COOL ACTIVE
REVERSING VALVE**

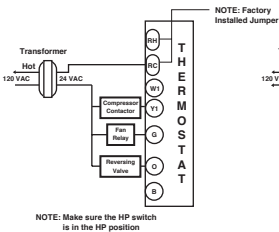

**HEAT PUMP WITH
HEAT ACTIVE
REVERSING VALVE**

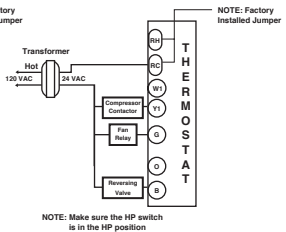

TERMINAL LEGEND - 8400			
TERM	EQUIPMENT TO CONNECT	REQ?	TERMINAL FUNCTION
Rh	24VAC hot connection	Yes	For input of 24VAC hot side of heat transformer
Rc	24VAC hot connection	Yes	For input of 24VAC hot side of cool transformer
W1	Heat connection	Yes*	Energizes on a call for heating
Y1	Compressor Connection	Yes*	Energizes on a call for cooling
B	Heat active reversing valve**	No	Energizes when in the HEAT mode
O	Cool active reversing valve**	No	Energizes when in the COOL mode
G	Indoor fan connection	Yes	Energizes with Y1 & W1 terminals or with FAN option switched to the ON position

* This thermostat can be used as a heat only or cool only thermostat therefore it is not always necessary to use both Y and W.

**The O and B terminals are accessory terminals that typically are used for heat pump applications.

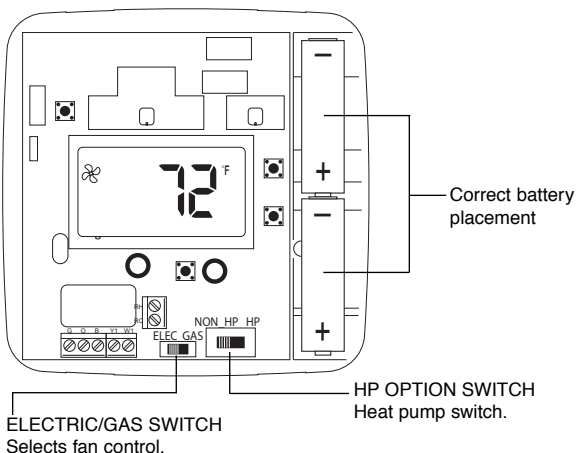

Figure 5

13. Make sure wire connections are secure.
14. Push excess wire back through opening.
15. Set the Electric/Gas switch to either GAS for a gas/oil heating system or ELEC for an electric heating system (Figure 5).
16. Set the HP option switch to either the HP for heat pump or NON_HP for furnace applications (Figure 5).
17. Install two AA Energizer brand batteries or equivalent into battery compartment as shown (Figure 5).
18. Replace thermostat cover by snapping into place.

Step 3: Testing the Thermostat

⚠ WARNING: DO NOT SHORT (JUMPER) ACROSS TERMINALS OF GAS VALVE OR SYSTEM CONTROL TO TEST OPERATION. THIS WILL DAMAGE THE THERMOSTAT AND VOID YOUR WARRANTY.

CAUTION: DO NOT SWITCH SYSTEM TO COOL IF THE TEMPERATURE IS BELOW 50°F (10°C). THIS CAN DAMAGE THE AIR CONDITIONING SYSTEM AND CAUSE PERSONAL INJURY.

1. Place the HEAT-OFF-COOL switch into the COOL position. The ❄ will be displayed.
2. Press the ▼ button until the temperature setting is at least 3 degrees below the room temperature. The air conditioning system should turn on within a few seconds.

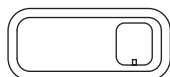

heat off cool

NOTE: ONCE THE THERMOSTAT TURNS OFF WHEN IN THE COOL MODE, A BUILT IN 5-MINUTE DELAY PREVENTS THE SYSTEM FROM TURNING ON AGAIN. THIS PROTECTS THE COMPRESSOR. NO ADDITIONAL TIME DELAY RELAY IS REQUIRED. TO OVERRIDE THE 5-MINUTE DELAY FOR INSTALLATION, PRESS THE RESET BUTTON.

3. Put the HEAT-OFF-COOL switch into the OFF position. The air conditioning system should turn off.

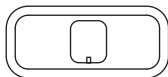

heat off cool

4. Put the HEAT-OFF-COOL switch into the HEAT position. The 🔥 will be displayed.

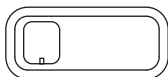

heat off cool

5. Press the ▲ button until the temperature setting is at least 3 degrees above room temperature. The heating system should turn on. The fan may not turn on immediately, depending on the fan delay built into the furnace.

NOTE: If HP is selected, the heat will not come on until the 5 minute short cycle protection has expired.

6. Put the HEAT-OFF-COOL switch into the OFF position. The heating system should turn off. The fan may continue to run for a short period of time.

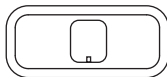

heat off cool

7. Put the 🌀 AUTO-ON switch into the ON position. The blower fan should turn on. The display will show a 🌀.



🌀 auto on

8. Put the 🌀 AUTO-ON switch into the AUTO position. The blower fan should turn off.



🌀 auto on

Step 4: Customizing the Thermostat

◆ Settings

System

Cool: The thermostat controls the cooling.

Off: The heating and cooling systems are off.

Heat: The thermostat controls the heat.

Fan







Auto: Equipment controls the fan.

On: The fan operates continuously.

◆ Temperature Differential

The temperature differential is factory set at 1.0°F (.5°C). This means that whenever the room temperature changes by one degree Fahrenheit from the temperature setting, the system will turn on. If the system turns on too often, increase the temperature differential.

◆ Changing Fahrenheit (°F) to Celsius (°C), the Temperature Differential, and the Filter Monitor

1. The thermostat is preset to display the temperature in degrees Fahrenheit (US models) or degrees Celsius (Canadian models). The temperature display can be changed. Press and hold both the ▲ and ▼ buttons for three seconds. The display will flash either an **F** or **C**. Release buttons. Press the ▲ or ▼ button to switch the display.
2. Wait five seconds or press  and the display will switch to the differential setting.
3. The display will read **diff**. The temperature differential is factory set at 1.0°F (0.5°C). Press the ▲ or ▼ button to adjust the differential up or down.
4. Wait five seconds or press  and the display will switch to the filter monitor setting.
5. **CHECK FILTER** and the length of hours for the filter monitor will be displayed.
6. Use the ▲ or ▼ to adjust the filter timer from 0 (OFF) to 9900 hours. **NOTE:** The filter timer is based on equipment run time. Select the length of time based on the recommended service interval for your filter.
7. Press the  to return to normal operation.

◆ Check Filter Reset

Once the filter timer has expired, **CHECK FILTER** will turn on and stay on. To clear the message and reset the timer:

1. Press the ▲ and ▼ buttons and hold for 3 seconds. **CLr** will appear in the time display.
2. Press any key to clear the message. The display will transition to the temperature scale display as described in the previous section.
3. No further input is needed. Within a few seconds, the display will return to the normal operating mode.

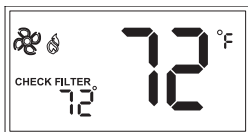

◆ Backlit Display

This thermostat is equipped with a backlight to make nighttime temperature adjustments quick and easy. Press the  button to activate the backlight. The backlight will turn off after about 10 seconds of inactivity.

◆ Reset

To reset the thermostat press the RESET button located above the upper left corner of the display.

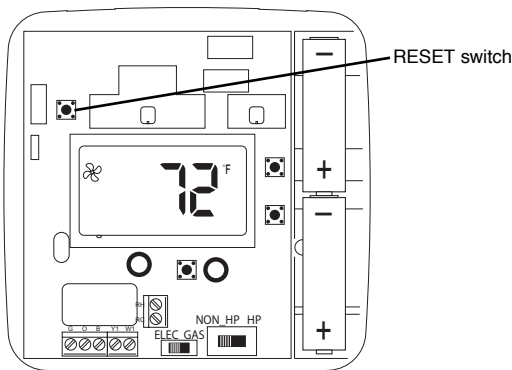

Step 5: Troubleshooting

Symptom	Remedy
Thermostat does not turn on system.	Check wiring (see Installation section).
Thermostat turns system on and off too frequently.	Increase temperature differential (see Changing the Temperature Differential section).
Display is blank, flashing or constant LOW BATT.	Replace batteries.
System fan does not operate properly.	Move Electric/Gas switch to either electric or gas, to match system (see Installation section).
Thermostat does not display proper room temperature.	Check F/C (Fahrenheit/Celsius) setting. See Changing Fahrenheit (F) to Celsius (C) .

If problems with thermostat cannot be resolved, call:

Technical Support: (800) 445-8299
Monday-Friday 7:30 AM - 5:30 PM CST

Two Year Limited Warranty

Climate Controls Americas warrants to the original contractor installer, or to the original consumer user, each new Robertshaw thermostat to be free from defects in materials and workmanship under normal use and service for a period of two (2) years from date of purchase. This warranty and our liability does not apply to batteries or merchandise that has been damaged by misuse, neglect, mishandling, alterations, improper installation, or use in a way other than in accordance with **Climate Controls Americas** recommendations and instructions.

Climate Controls Americas agrees to repair or replace at its option any thermostat under warranty provided it is returned within the warranty period, postage prepaid, with proof of the date of purchase. Cost of thermostat removal or reinstallation is not the responsibility of **Climate Controls Americas**.

Repair or replacement as provided under this warranty is the exclusive remedy of the consumer. **Climate Controls Americas** shall not be liable for any incidental or consequential damages for breach of any express or implied warranty on this product, or under any other theory of liability. Except to the extent prohibited by applicable law, any implied warranty of merchantability or fitness for a particular purpose on this product is limited to the duration of this warranty.

Some states do not allow the exclusion or limitation of incidental or consequential damages, or allow limitations on how long an implied warranty lasts, so the above limitations or exclusions may not apply to you. This warranty gives you specific legal rights, and you may also have other rights which vary from state to state.

For warranty returns, send thermostat, shipping prepaid to:

Climate Controls Americas
Warranty Claims Department
515 S. Promenade
Corona, CA 91719

invensys. **Climate Controls Americas**
191 E. North Avenue
Carol Stream, Illinois 60188
United States of America

NOTES