

Robertshaw®

9401

DIGITAL
NON-PROGRAMMABLE
THERMOSTAT

NEW



GAS ELECTRIC OIL

1 Heat / 1 Cool



**User's Manual
Quick Start
Installation**



110-1041

Application

The Robertshaw 9401 is a single-stage thermostat designed to control 24 VAC gas or electric heating and cooling systems or single-stage heat pump. The 9401 requires the use of a common wire.

Features

- Summer and winter setpoints
- Large back lit display
- Adjustable temperature differential: .5°F to 3.0°F (0.5°C to 1.5°C)
- Compressor short cycle protection
- Accuracy within $\pm 1^\circ$
- Zone system compatible as a master thermostat
- Permanent memory retention
- Fahrenheit/Celsius display option
- Adjustable from 45°F to 90°F (7°C - 32°C)
- Quick wire terminal block
- Automatic heating shutdown if temperature exceeds 94°F (34°C)

▲ IMPORTANT SAFETY INFORMATION WARNING:

- Always turn off power at main fuse or circuit breaker panel before installing, removing, cleaning, or servicing thermostat.
- Read all the information in this manual before installing this thermostat.
- This is a 24 VAC low-voltage thermostat. Do not install on voltages higher than 30 VAC.
- All wiring must conform to local and national building and electrical codes and ordinances.
- Do not short (jumper) across terminals on the gas valve or at the system control to test installation. This will damage the thermostat and void the warranty.
- Do not connect ground to any terminal in this unit.

Step 1: Replacing Existing Thermostat

1. Turn off power to heating and cooling system.
2. Remove cover from old thermostat to expose wires (Figure 1).

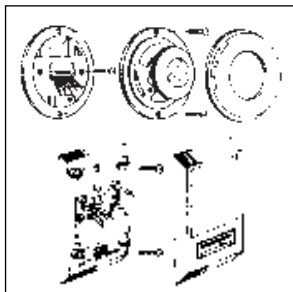

Figure 1

3. Disconnect wires one at a time from existing terminals. Use enclosed labels to mark existing wires. Refer to cross references in Table 1 if existing wiring does not directly match the labels.
4. Remove existing thermostat base from wall.

| Old Terminal | New Label | Description |
|---------------------|------------------|--------------------------------|
| M,W,Rh,R5 or 5 | Rh | Heat transformer, hot side |
| V or Rc | Rc | Cool transformer, hot side |
| C,X, or B | C | 24VAC transformer, common side |
| Y or Y6 | Y | Cooling control |
| H,W, or 4 | W | Heating control |
| F or G | G | Fan control relay |
| O | O | Cool active reversing valve |
| B | B | Heat active reversing valve |

NOTE: THIS THERMOSTAT REQUIRES A 24V AC COMMON WIRE FOR PROPER OPERATION.

Table 1



Recycling Thermostat

If this thermostat is replacing a thermostat that contains mercury in a sealed tube, do not place your old thermostat in the garbage. Contact your local waste management authority for instructions regarding proper disposal of the thermostat. If you have any questions, call Robertshaw technical support at 1-800-445-8299.

Step 2: Installing Model 9401 Thermostat

NOTE: FOR NEW INSTALLATIONS, MOUNT THERMOSTAT ON INSIDE WALL, FIVE FEET ABOVE THE FLOOR. DO NOT INSTALL BEHIND A DOOR, IN A CORNER, NEAR AIR VENTS, IN DIRECT SUNLIGHT, OR NEAR ANY HEAT OR STEAM GENERATING FIXTURES. INSTALLATION AT THESE LOCATIONS WILL AFFECT THERMOSTAT OPERATION.

1. Turn power off to the heating and cooling systems.
2. Place HEAT-OFF-COOL in OFF position (Figure 2).
3. Place ❄️-ON-AUTO switch into AUTO position (Figure 2).

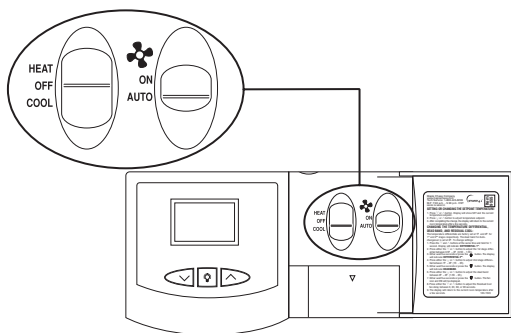

Figure 2

4. Remove the cover using a coin or screwdriver (Figure 3). Set aside.

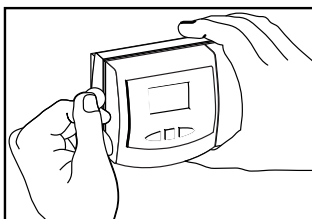

Figure 3

5. Place thermostat against the wall at desired location. Make sure wires will feed through opening (Figure 4) on base of thermostat.
6. Mark placement of mounting holes (Figure 4). Set base aside.

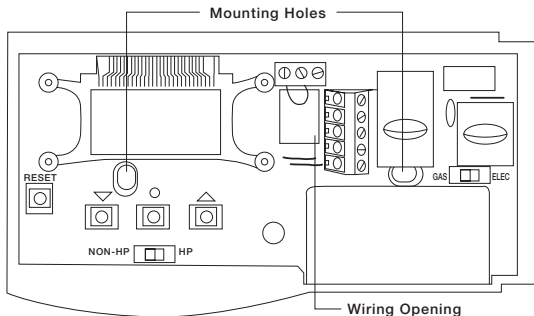

Figure 4

7. If mounting on drywall, tap plastic anchors into wall.

NOTE: ENCLOSED PLASTIC ANCHORS DO NOT REQUIRE A DRILLED HOLE FOR DRYWALL.

8. If mounting on a surface other than drywall, drill the marked holes using a 3/16" drill bit.
9. Align base with plastic anchors and feed wires through opening.
10. Secure base to wall with supplied screws.

NOTE: THE THERMOSTAT WILL MOUNT HORIZONTALLY ON A SINGLE GANG JUNCTION BOX.

11. Strip end of wires 5/16" if needed.
12. Terminal screws are already loose and ready for wire insertion. Insert wires into terminal strip (Figure 5) matching the label to the corresponding terminal (see **Wiring Diagrams**). Tighten screws.
13. Make sure wire connections are secure.
14. Push excess wire back through opening.

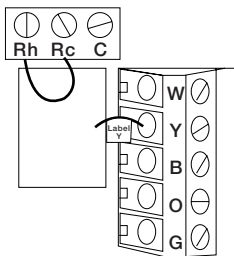
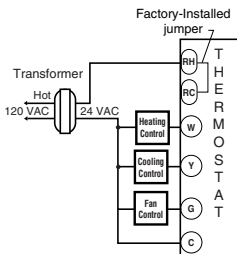

Figure 5

◆ Wiring Diagrams

**HEAT/COOL
4-WIRE
SINGLE TRANSFORMER**



**HEAT ONLY
3-WIRE
SINGLE TRANSFORMER**

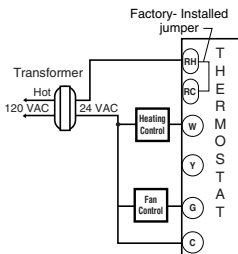

**HEAT ONLY
2-WIRE
SINGLE TRANSFORMER**

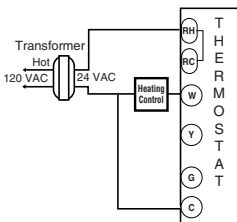

**COOL ONLY
3-WIRE
SINGLE TRANSFORMER**

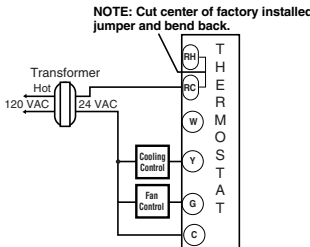

**HEAT/COOL
5-WIRE
TWO TRANSFORMER**

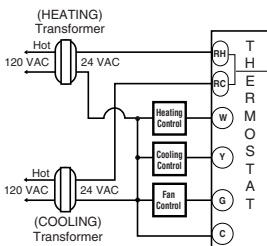

NOTE: Cut center of factory installed jumper and bend back

NOTE: Both transformers must be in phase.

**HEAT PUMP WITH
COOL ACTIVE
REVERSING VALVE**

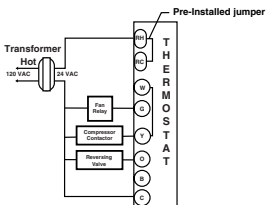

NOTE: Installer must place jumper between W and Y terminals.

**HEAT PUMP WITH
HEAT ACTIVE
REVERSING VALVE**

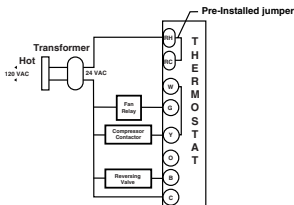

NOTE: Installer must place jumper between W and Y terminals.

TERMINAL LEGEND - 9401

| TERM | EQUIPMENT TO CONNECT | REQ? | TERMINAL FUNCTION |
|------|-----------------------------|------|---|
| Rh | 24VAC hot connection | Yes | For input of 24VAC hot side of heat transformer |
| Rc | 24VAC hot connection | Yes | For input of 24VAC hot side of cool transformer |
| C | 24VAC common connection | Yes | For input of 24VAC common side of transformer |
| W | Heat connection | Yes* | Energizes on a call for heating |
| Y | Compressor Connection | Yes* | Energizes on a call for cooling |
| B | Heat Active Reversing Valve | No | Energizes when in the HEAT mode |
| O | Cool Active Reversing Valve | No | Energizes when in the COOL mode |
| G | Indoor fan connection | Yes | Energizes with Y & W terminals in electric mode; or with Y terminal in gas mode; or with FAN option switched to the ON position |

* This thermostat can be used as a heat only or cool only thermostat therefore it is not always necessary to use both Y and W.

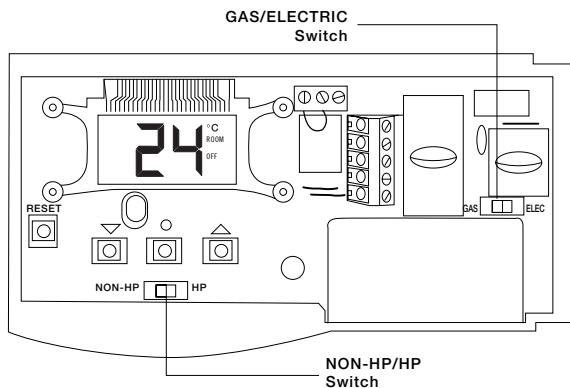

Figure 6

15. Set the GAS/ELEC switch to either GAS for a gas/oil heating system or ELEC for an electric heating system (Figure 6).
16. Set the HP/NON-HP switch to either the HP for heat pump or NON-HP for furnace applications (Figure 6).
17. Replace thermostat cover by snapping into place.

Step 3: Testing the Thermostat

⚠ WARNING: DO NOT SHORT (JUMPER) ACROSS TERMINALS OF GAS VALVE OR SYSTEM CONTROL TO TEST OPERATION. THIS WILL DAMAGE THE THERMOSTAT AND VOID YOUR WARRANTY.

CAUTION: DO NOT SWITCH SYSTEM TO COOL IF THE TEMPERATURE IS BELOW 50°F (10°C). THIS CAN DAMAGE THE AIR CONDITIONING SYSTEM AND CAUSE PERSONAL INJURY.

1. Place the HEAT-OFF-COOL switch into the COOL position. The display will read COOL.
2. Press the ∇ button until the temperature setting is at least 3 degrees below the room temperature. The air conditioning system should turn on within a few seconds. The snowflake icon will be displayed.

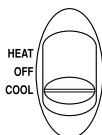

NOTE: ONCE THE THERMOSTAT TURNS OFF WHEN IN THE COOL MODE, A BUILT IN 5-MINUTE DELAY PREVENTS THE SYSTEM FROM TURNING ON AGAIN. THIS PROTECTS THE COMPRESSOR. NO ADDITIONAL TIME DELAY RELAY IS REQUIRED. TO OVERRIDE THE 5-MINUTE DELAY FOR INSTALLATION, PRESS THE RESET BUTTON.

3. Put the HEAT-OFF-COOL switch into the OFF position. The air conditioning system should turn off.

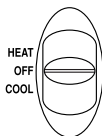

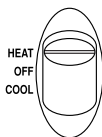

4. Put the HEAT-OFF-COOL switch into the HEAT position. The display will read HEAT.



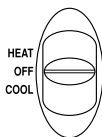

5. Press the \wedge button until the temperature setting is at least 3 degrees above room temperature. The heating system should turn on. The fan may not turn on immediately, depending on the fan delay built into the furnace. The flame icon will be displayed.

6. Put the HEAT-OFF-COOL switch into the OFF position. The heating system should turn off. The fan may continue to run for a short period of time.

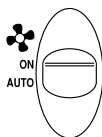

7. Put the  -ON-AUTO switch into the ON position. The blower fan should turn on.
The display will show a  and ON.



8. Put the  -ON-AUTO switch into the AUTO position. The blower fan should turn off.

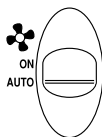

Step 4: Customizing the Thermostat

◆ Settings

System

Cool: The thermostat controls the cooling.

Off: The heating and cooling systems are off.



Heat: The thermostat controls the heat.



Fan

Auto: Equipment controls the fan.

On: The fan operates continuously.

Temperature

Heating: The default temperature for heating is 70°F (21°C). To change the default setpoint, put the system switch in HEAT and press the  or  button to adjust the temperature setting up or down. The display will show SET. The display will return to the current room temperature three seconds after the last input and the new setpoint will be saved.

Cooling: The default temperature for cooling is 78°F (25°C). To change the default setpoint, put the system switch in COOL and press the  or  button to adjust the temperature setting up or down. The display will show SET. The display will return to the current room temperature three seconds after the last input and the new setpoint will be saved.

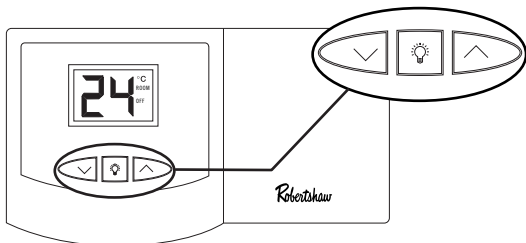

Figure 7

◆ Temperature Differential

The temperature differential is factory set at 1.0°F (.5°C). This means that whenever the room temperature changes by one degree Fahrenheit from the temperature setting, the system will turn on. If the system turns on too often, increase the temperature differential.

◆ Changing Fahrenheit (°F) to Celsius (°C), and the Temperature Differential

1. The thermostat is preset to display the temperature in degrees Fahrenheit (US models) or degrees Celsius (Canadian models). The temperature display can be changed. Press and hold both the \wedge and \vee button for three seconds. The display will read F or C. Release buttons. Press the \wedge or \vee button to switch the display.
2. After three seconds the display will switch to the differential settings. The display will read SET DIFF.
3. The temperature differential is factory set at 1.0°F (0.5°C). Press the \wedge or \vee button to adjust the differential up or down.
4. Wait three seconds or press lightbulb and the display will return to the original room temperature.

◆ Backlit Display

This thermostat is equipped with a backlight to make nighttime temperature adjustments quick and easy. Press the lightbulb button to activate the backlight. The backlight will turn off after about 5 seconds of inactivity.

◆ Reset

To reset the thermostat press the RESET button located at the lower left corner of the base.

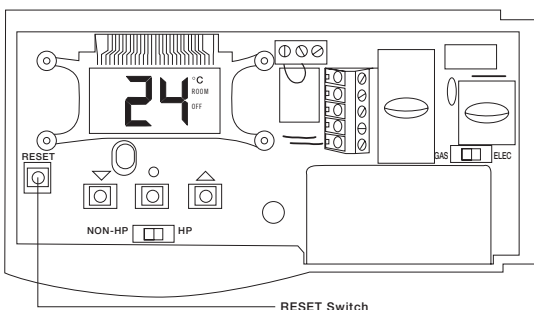

Step 5: Troubleshooting

| Symptom | Remedy |
|--|--|
| Thermostat does not turn on system. | Check wiring (see Installation section). |
| Thermostat turns system on and off too frequently. | Increase temperature differential (see Changing the Temperature Differential section). |
| System fan does not operate properly. | Move fan option switch to either gas or electric, to match system (see Installation section). |
| Thermostat does not display proper room temperature. | Check F/C (Fahrenheit/Celsius) setting. See Changing Fahrenheit (F) to Celsius (C). |

If problems with thermostat cannot be resolved, call:

Technical Support: (800) 445-8299
Monday-Friday 7:30 AM - 5:30 PM CST

Two Year Limited Warranty

Climate Controls NA warrants to the original contractor installer, or to the original consumer user, each new Robertshaw thermostat to be free from defects in materials and workmanship under normal use and service for a period of two (2) years from date of purchase. This warranty and our liability does not apply to batteries or merchandise that has been damaged by misuse, neglect, mishandling, alterations, improper installation, or use in a way other than in accordance with **Climate Controls NA** recommendations and instructions.

Climate Controls NA agrees to repair or replace at its option any thermostat under warranty provided it is returned within the warranty period, postage prepaid, with proof of the date of purchase. Cost of thermostat removal or reinstallation is not the responsibility of **Climate Controls NA**

Repair or replacement as provided under this warranty is the exclusive remedy of the consumer. **Climate Controls NA** shall not be liable for any incidental or consequential damages for breach of any express or implied warranty on this product, or under any other theory of liability. Except to the extent prohibited by applicable law, any implied warranty of merchantability or fitness for a particular purpose on this product is limited to the duration of this warranty.

Some states do not allow the exclusion or limitation of incidental or consequential damages, or allow limitations on how long an implied warranty lasts, so the above limitations or exclusions may not apply to you. This warranty gives you specific legal rights, and you may also have other rights which vary from state to state.

For warranty returns, send thermostat, shipping prepaid to:

Invensys Climate Controls NA
Warranty Claims Department
515 S. Promenade
Corona, CA 91719

 **Climate Controls NA**
191 E. North Avenue
Carol Stream, Illinois 60188
United States of America

NOTES